

CAPS

S153-LOZ/90(каркас)

A	B	C	D	
1	S153-1109	2000	260	2/3
2	S153-0007	960	795	1/3
3	S153-1110	903	200	2/3
4	S153-0006	960	495	1/3
5	S153-5574	402	49	3/3
6	S153-5575	469	49	3/3

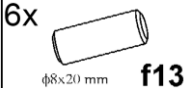
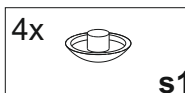
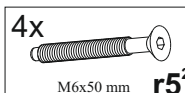
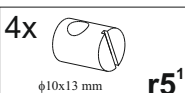
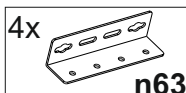
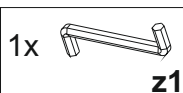
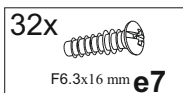
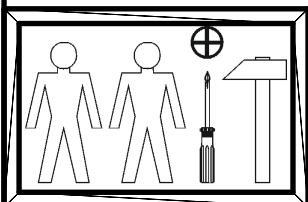
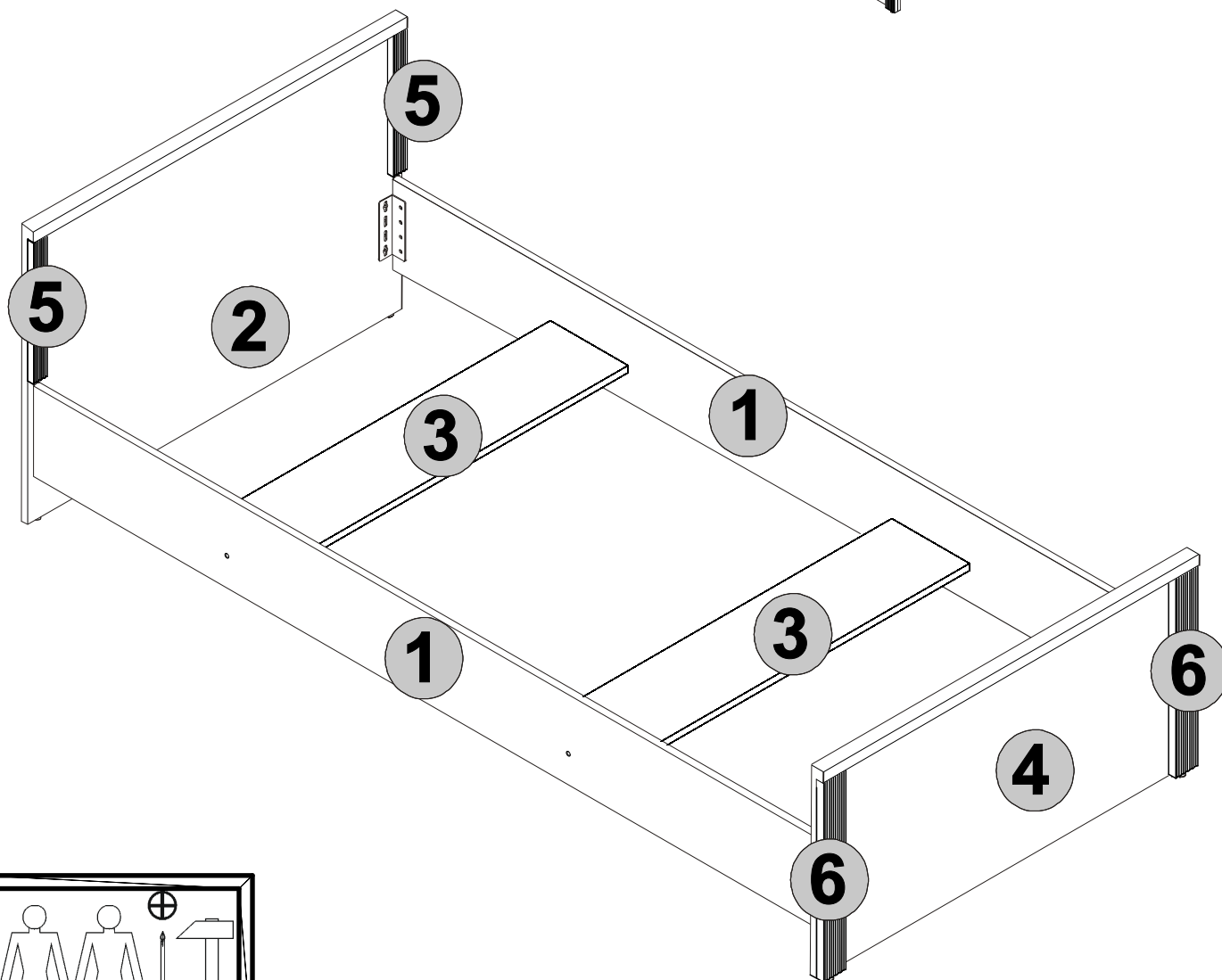
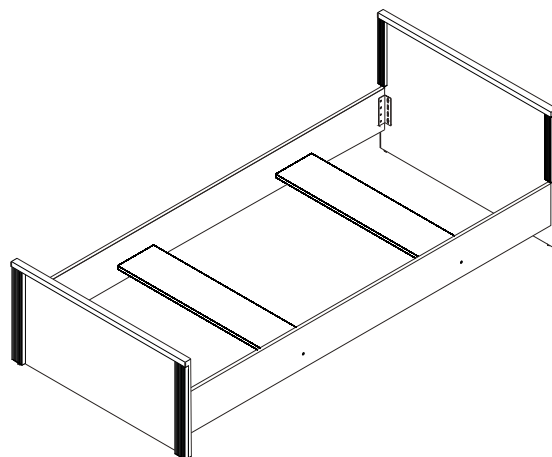

1

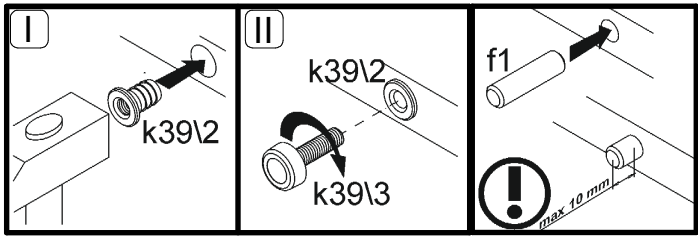
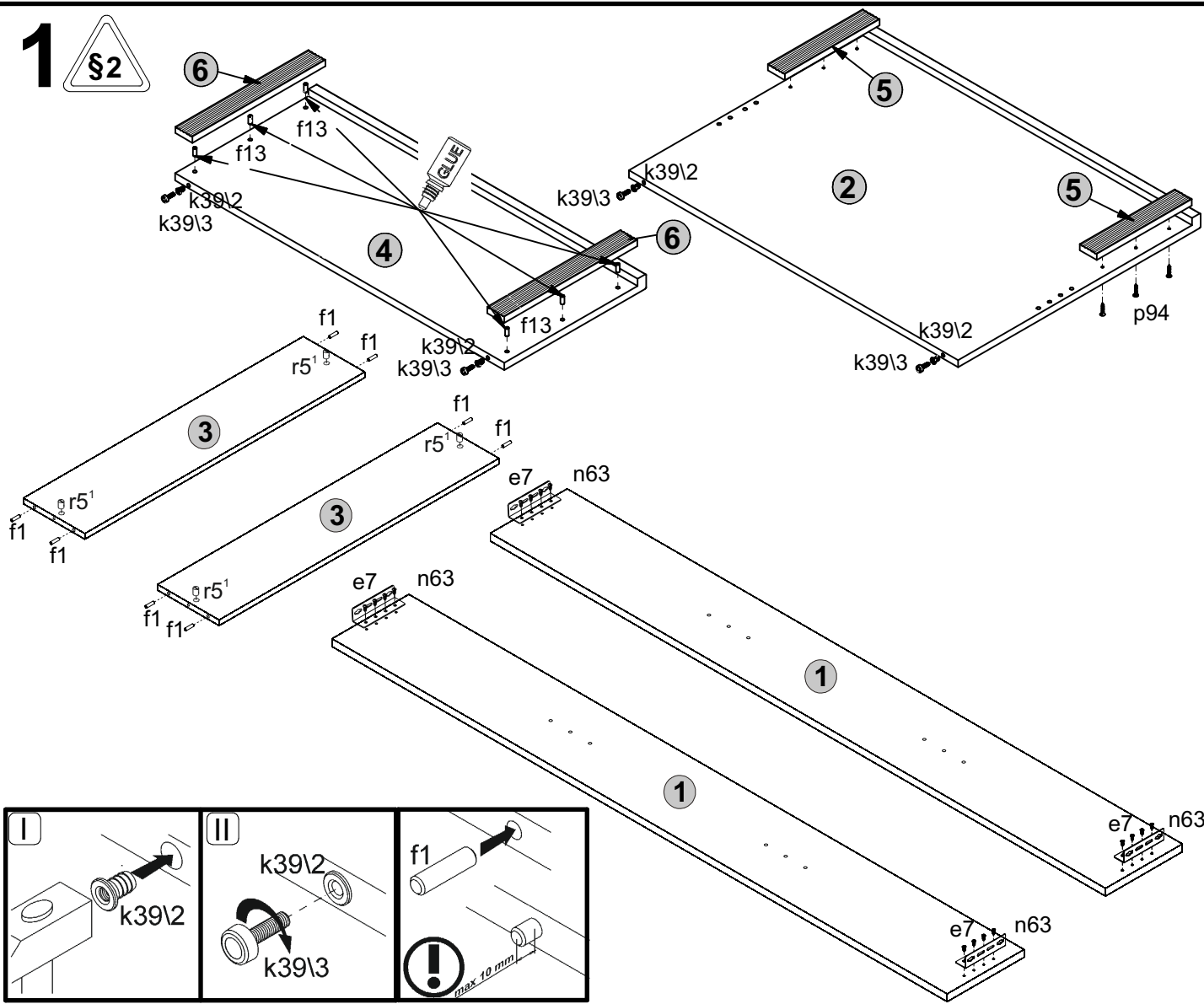

2

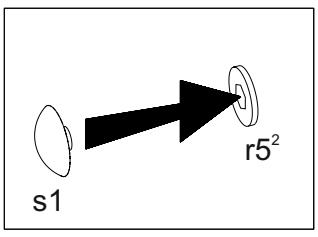
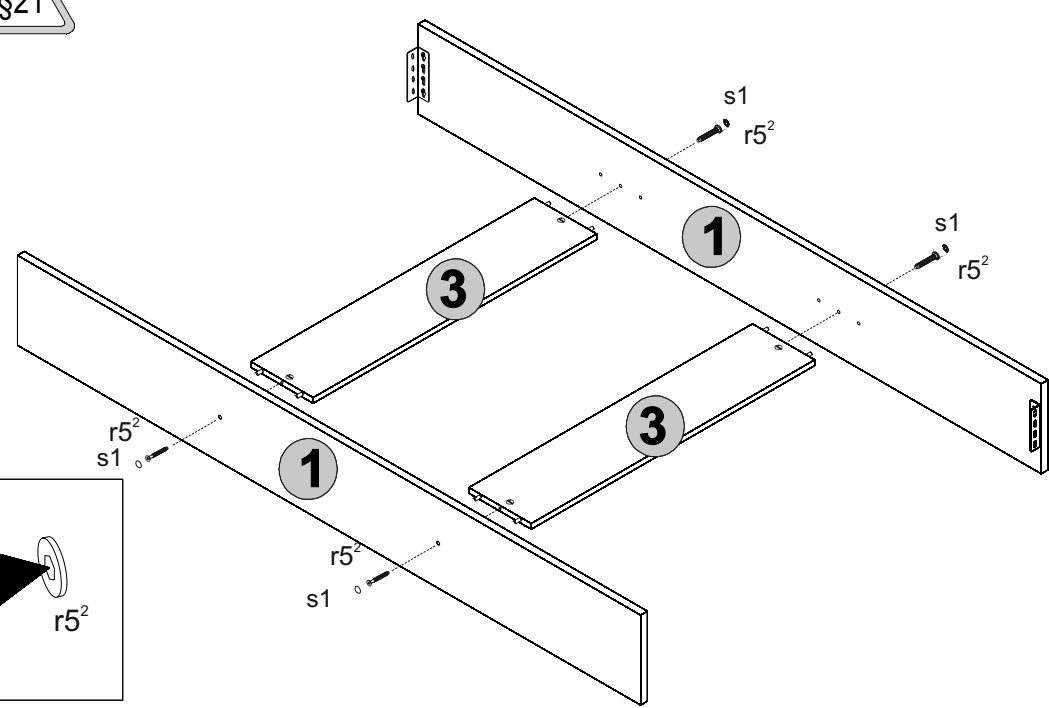

3

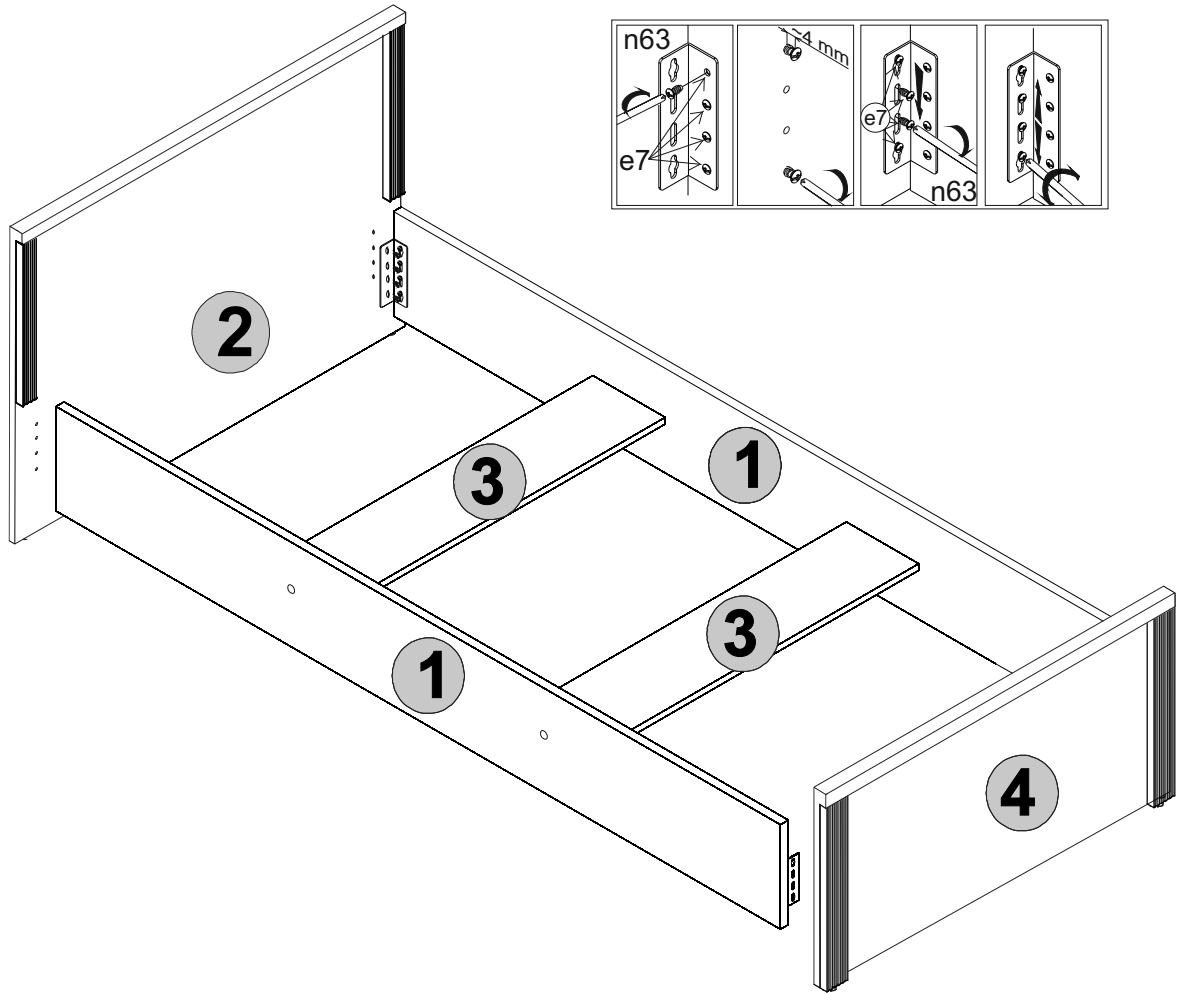

4

